



Задачи и инструменты майнтейнеров ОС Linux

Владимир Рубанов

Первый зам. ген. директора ЗАО «РОСА»

к.ф.-м.н., доцент, РМР

Пономаренко Андрей

Старший инженер-программист ЗАО «РОСА»

Москва, 1-2 ноября 2012 г.

Дистрибутивы Linux

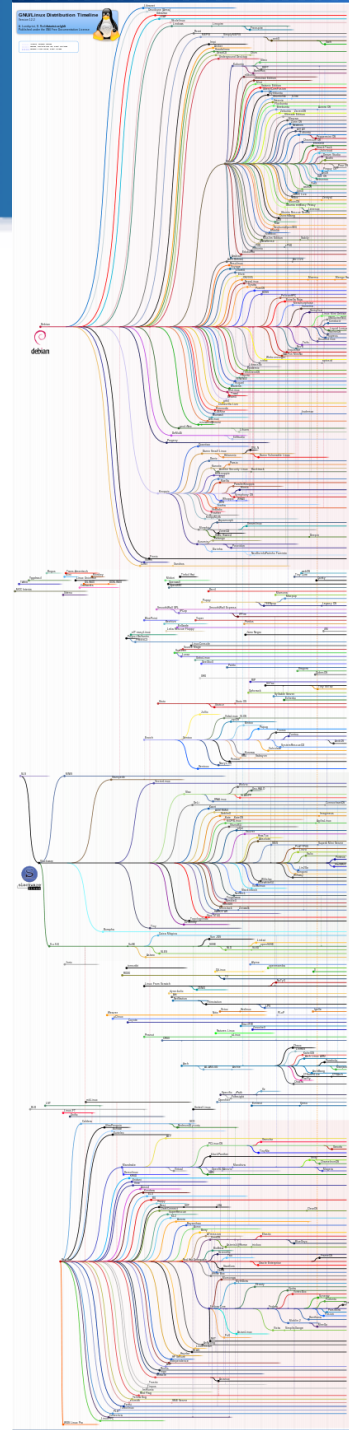

Майнтейнеры ROSA Linux

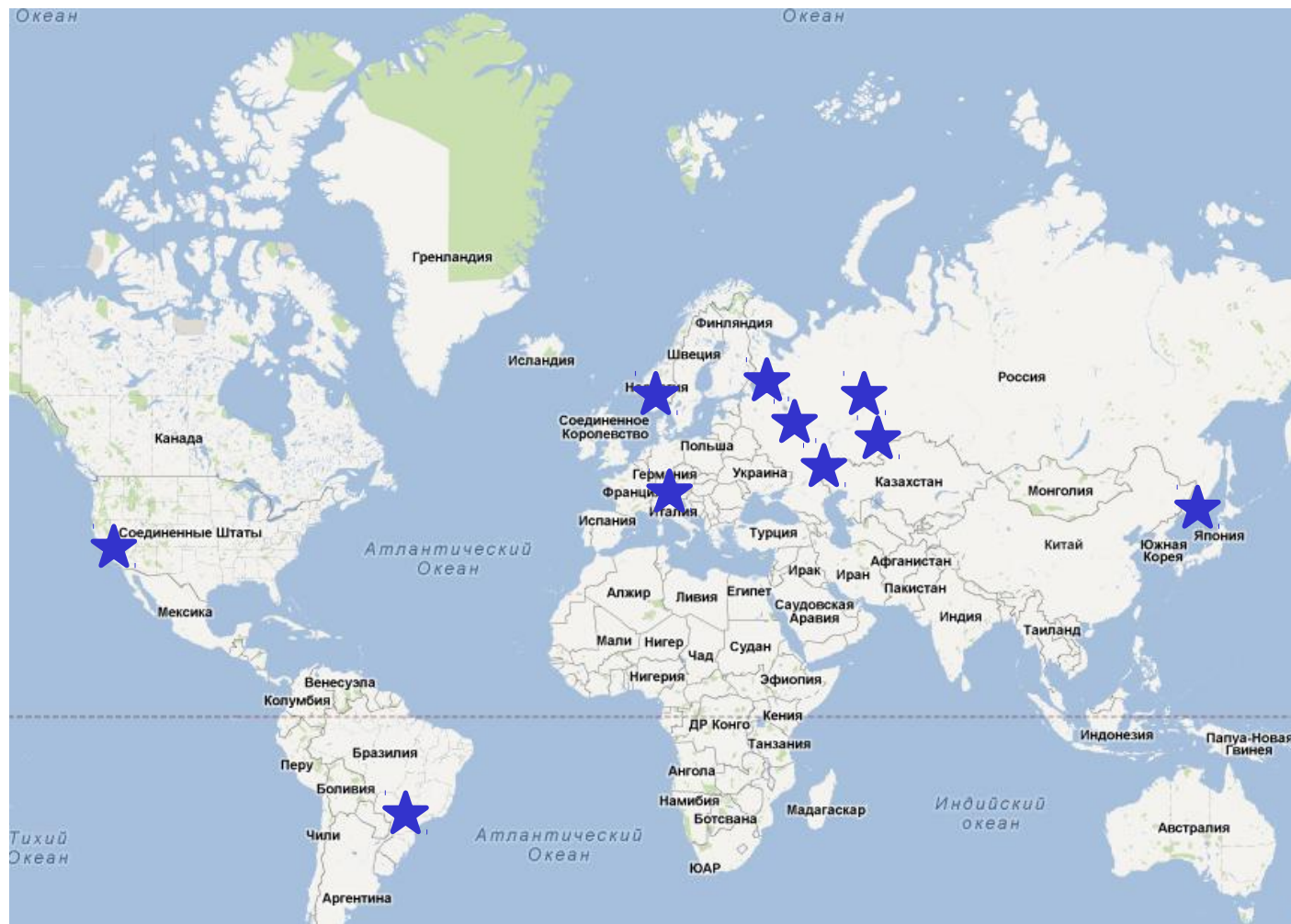

Цели дистрибутивов Linux

- Свежие и стабильные версии ПО
- Максимальное разнообразие ПО
- Особая приправа: “Фирменное” ПО



Задачи майнтейнеров

- Создание установочных пакетов

RPM, DEB, ...

- Обновление компонентов

- Тестирование

- ...

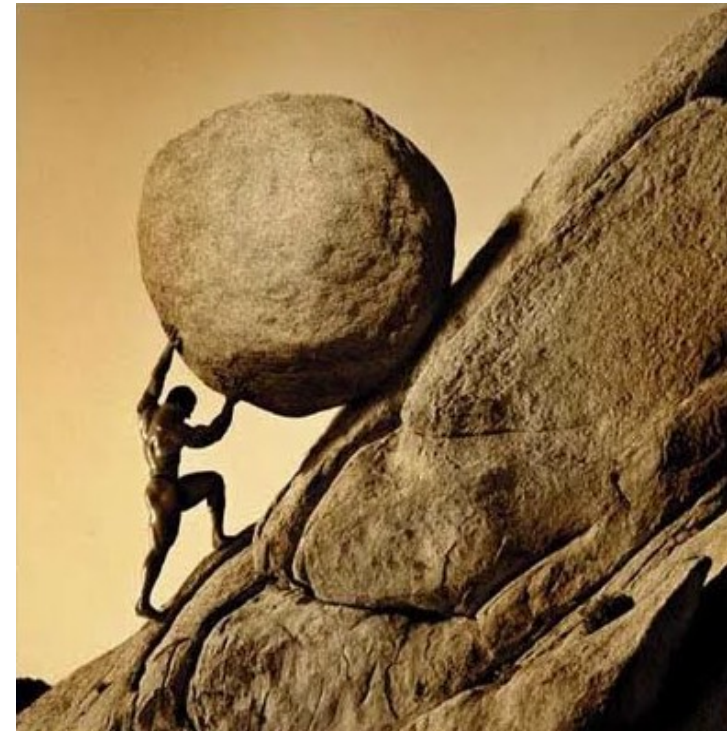

Базовые термины

- Компонент
- Апстрим
- Пакет (RPM, DEB)
- Репозиторий
- Зависимость
- Интерфейс
- Совместимость

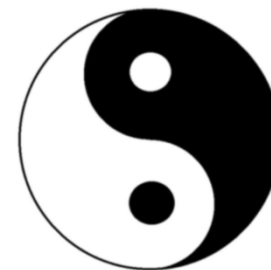

Компоненты ОС



Приложения
(Firefox, OpenOffice и др.)

Кол-во: ~100



**Библиотеки
и системные утилиты**
(Glibc, Gtk и др.)

Кол-во: ~10.000

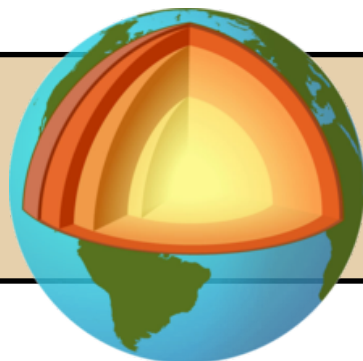

Ядро

Кол-во: ~1-2

Зависимости: прямые и обратные

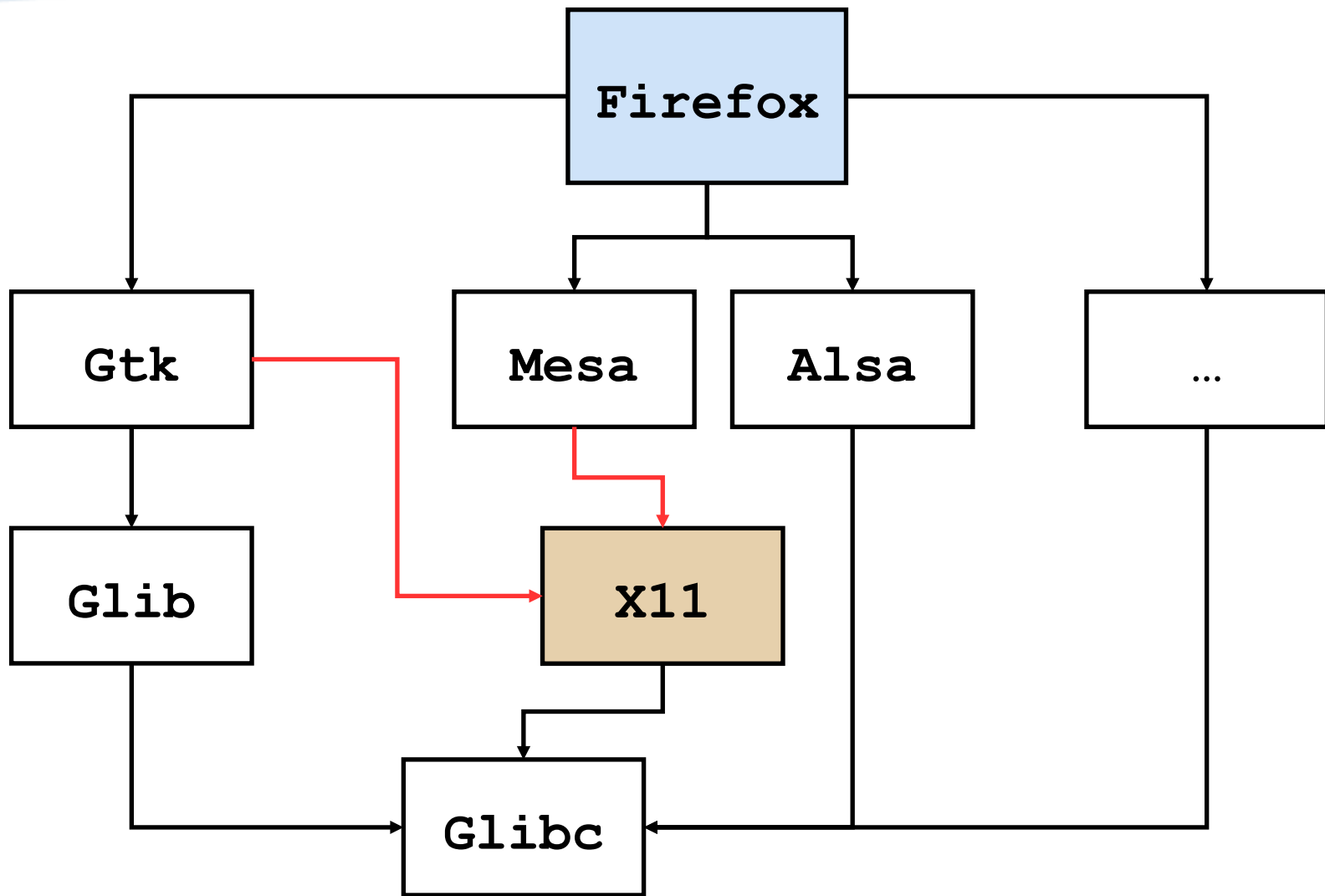

Совместимость

X (v1.0)

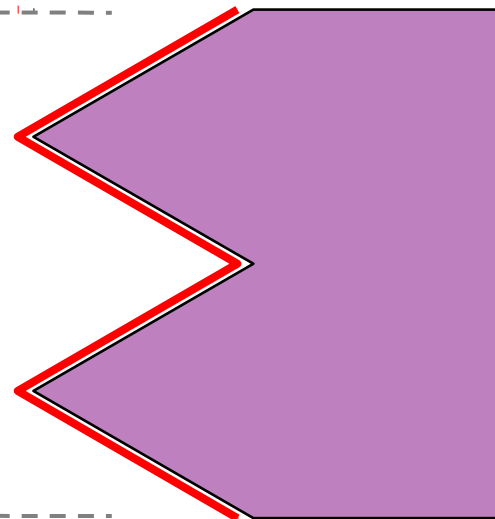
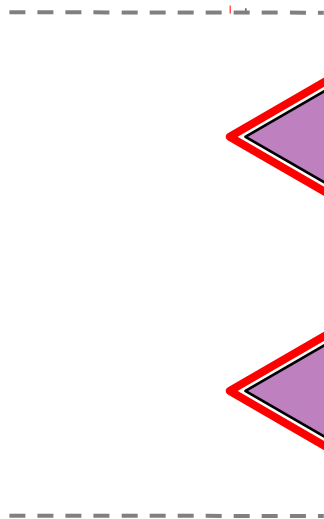
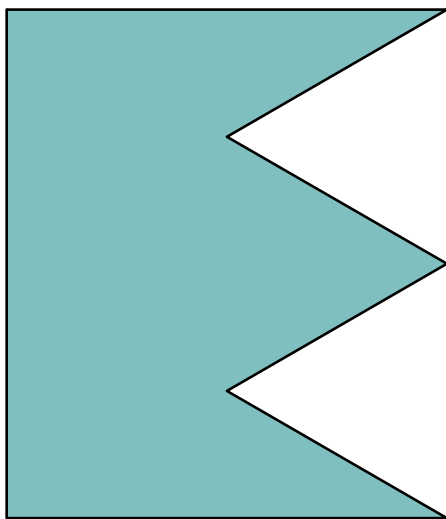

Y

Совместимость

X (v1.0)

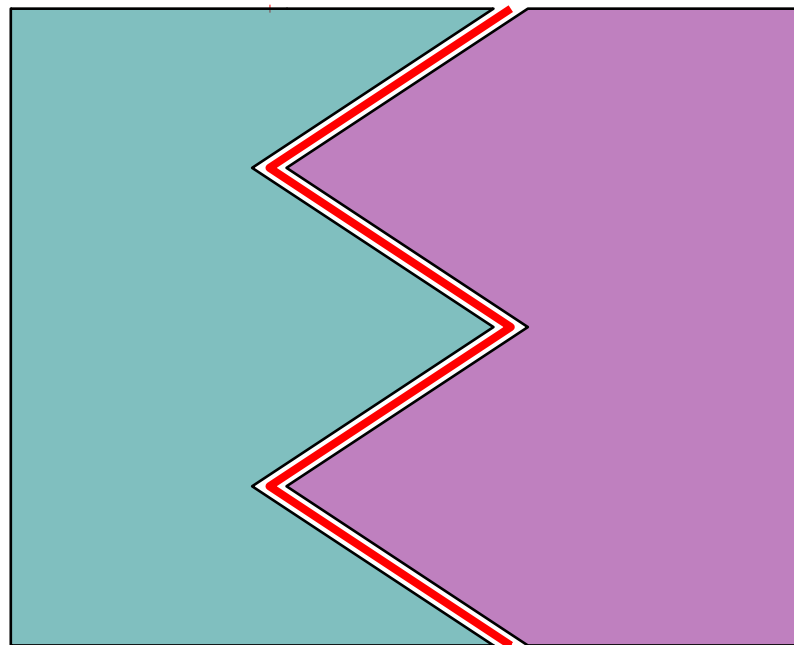

Y

Совместимость

X (v2.0)

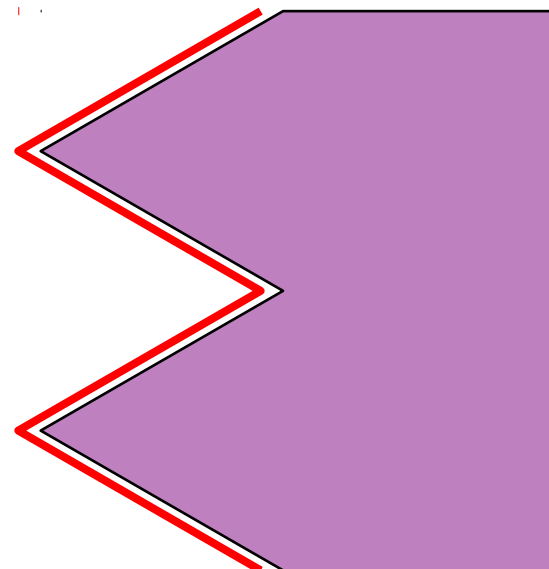
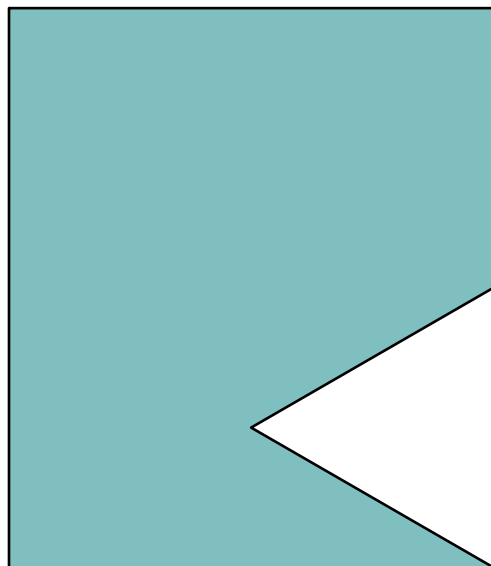

Y

Совместимость

X (v2.0)

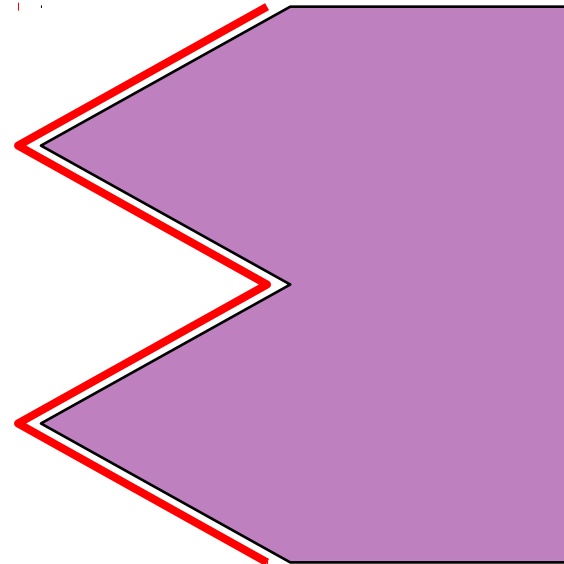
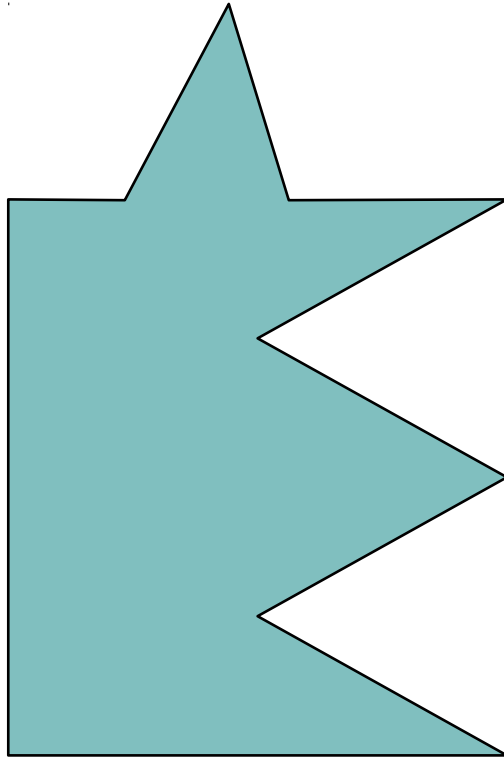

Y

Виды совместимости

Бинарная

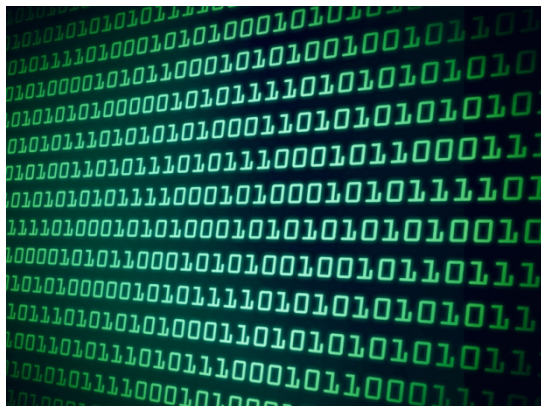

На уровне исходных кодов

```
void Page_Loaded(  
    object sender, RoutedEventArgs e )  
{  
    CompositeButton.MouseMove +=  
        new MouseEventHandler(  
            CompositeButton_MouseMove);  
}  
  
void CompositeButton_MouseMove(  
    object sender, MouseEventArgs e )  
{  
    if (trackingMouseMove)  
    {  
    }  
}
```

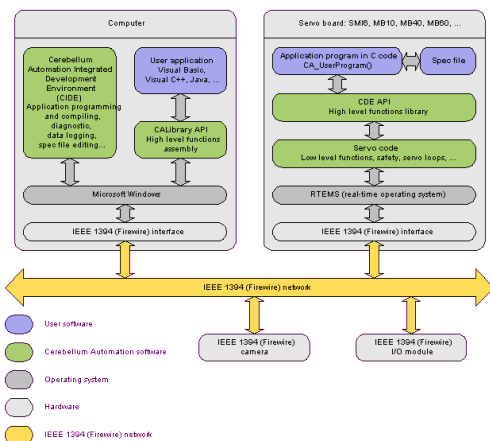

Функциональная

Обновление компонента

- Какие зависимости? Прямые и обратные?
- Интерфейсы?
 - Как и кем используются?
 - Что изменилось?
 - Изменения совместимы?
- Что может сломаться?



Требования к дистрибутиву

- Все пакеты:
 - ✓ Собираются **без ошибок**
 - ✓ Устанавливаются
- Все приложения **работают правильно**
- **Совместимость обновлений**



Требования к репозиториям

- Замкнутость по зависимостям
- Отсутствие конфликтов по файлам

✓ Путям инсталляции файлов

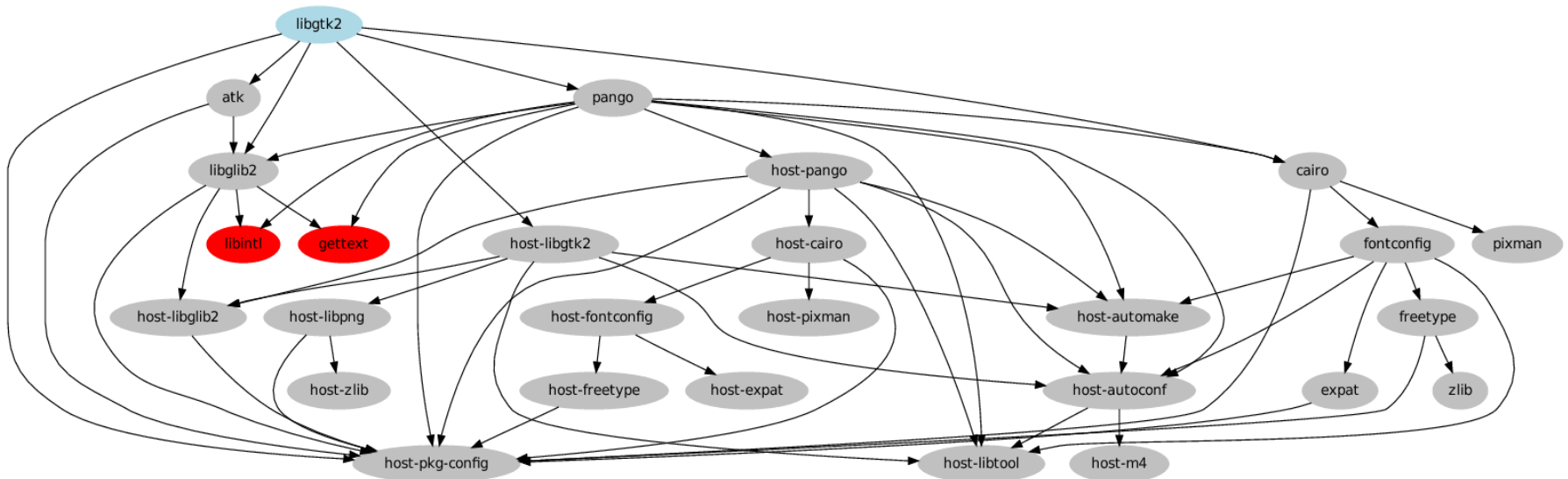

Виды тестирования

- **Функциональное**
- **Структурное**



Инструменты: URPM-Repoclosure

- **Замкнутость** репозитория по зависимостям
- Проверяет собранный репозиторий
- Виды анализа:
 - статический
 - динамический

<http://fba.rosalinux.ru/repoclosure/>

Отчеты: URPM-Repoclosure

URPM-repoclosure report

This report has been generated for this [hdlist](#) on Sep 28 20:05 2012.

Test Info

Repository	ROSA 2012 Desktop/i586- main
Unresolved Dependencies	9 (0.1%)
Broken Packages	6 (0.05%)



Dependency (9)	RPM	SRPM
gstreamer0.10(encoder-video/x-vp8)	cheese-3.5.2-1-rosa2012.1.i586	cheese-3.5.2-1
kernel-xen-pvops	xen-4.1.2-3-rosa2012.1.i586	xen-4.1.2-3
libgnome-desktop-3.so.2	gnome-screensaver-3.4.4-1-rosa2012.1.i586	gnome-screensaver-3.4.4-1
libspice-client-glib-2.0.so.1	vinagre-3.4.1-1-rosa2012.1.i586	vinagre-3.4.1-1
libspice-client-glib-2.0.so.1(SPICEGTK_1)	vinagre-3.4.1-1-rosa2012.1.i586	vinagre-3.4.1-1
libspice-client-gtk-3.0.so.1	vinagre-3.4.1-1-rosa2012.1.i586	vinagre-3.4.1-1
libspice-client-gtk-3.0.so.1(SPICEGTK_1)	vinagre-3.4.1-1-rosa2012.1.i586	vinagre-3.4.1-1
libusbredirparser.so.0	qemu-img-1.2.0-2-rosa2012.1.i586	qemu-1.2.0-2
mozilla-thunderbird == 10.0.2	mozilla-thunderbird-zh_TW-10.0.2-0.1-rosa2012.1.noarch	mozilla-thunderbird-i10n-10.0.2-0.1

Broken Packages (6)

cheese
gnome-screensaver
mozilla-thunderbird-zh_TW
qemu-img
vinagre



Инструменты: ABI Compliance Checker

- **Анализ совместимости** версий Си/C++ библиотек
- **Приоритезация** найденных проблем
- Используется в
 - **Upstream**: разработчиками библиотек
 - **Downstream**: майнтейнерами

<http://github.com/lvc/abi-compliance-checker>

Отчеты: ABI Compliance Checker

Binary compatibility report for the **libssh** library between **0.4.8** and **0.4.90** versions on **x86**

Test Info

Library Name	libssh
Version #1	0.4.8
Version #2	0.4.90
CPU Type	x86
GCC Version	4.6.1

Test Results

Total Header Files	5
Total Shared Libraries	1
Total Symbols / Types	210 / 105
Verdict	Incompatible (1.7%)



Problem Summary

	Severity	Count
Added Symbols	-	66
Removed Symbols	High	3
	High	0
	Medium	0
Problems with Data Types	Low	2
	High	1
	Medium	1
Problems with Symbols	Low	1
	Low	0
Problems with Constants	Low	0
Other Changes in Data Types	-	3



Отчеты: ABI Compliance Checker

Problems with Data Types, Medium Severity (1)

sftp.h

[-] struct **sftp_session_struct** (1)

	Change	Effect
1	Field errnum has been added at the middle position of this structural type.	1) Size of the inclusive type has been changed. 2) Layout of structure fields has been changed and therefore fields at higher positions of the structure definition may be incorrectly accessed by applications.

[-] affected symbols (35)

sftp_canonicalize_path (SFTP_SESSION* *sftp*, char* *path*)
1st parameter 'sftp' (pointer) has base type 'sftp_session_struct'.

sftp_client_message_free (SFTP_CLIENT_MESSAGE* *msg*)
Field 'msg->sftp' in 1st parameter 'msg' (pointer) has base type 'sftp_session_struct'.

sftp_dir_close (SFTP_DIR* *dir*)
Field 'dir->sftp' in 1st parameter 'dir' (pointer) has base type 'sftp_session_struct'.

sftp_dir_eof (SFTP_DIR* *dir*)
Field 'dir->sftp' in 1st parameter 'dir' (pointer) has base type 'sftp_session_struct'.

sftp_file_close (SFTP_FILE* *file*)
Field 'file->sftp' in 1st parameter 'file' (pointer) has base type 'sftp_session_struct'.

sftp_free (SFTP_SESSION* *sftp*)
1st parameter 'sftp' (pointer) has base type 'sftp_session_struct'.

sftp_fstat (SFTP_FILE* *file*)
Field 'file->sftp' in 1st parameter 'file' (pointer) has base type 'sftp_session_struct'.

sftp_get_client_message (SFTP_SESSION* *sftp*)
1st parameter 'sftp' (pointer) has base type 'sftp_session_struct'.

sftp_handle (SFTP_SESSION* *sftp*, STRING* *handle*)
1st parameter 'sftp' (pointer) has base type 'sftp_session_struct'.

sftp_handle_alloc (SFTP_SESSION* *sftp*, void* *info*)
1st parameter 'sftp' (pointer) has base type 'sftp_session_struct'.

sftp_handle_remove (SFTP_SESSION* *sftp*, void* *handle*)
1st parameter 'sftp' (pointer) has base type 'sftp_session_struct'.

sftp_init (SFTP_SESSION* *sftp*)
1st parameter 'sftp' (pointer) has base type 'sftp_session_struct'.

Разбор конкретных проблем

Отчеты: ABI Compliance Checker

Added Symbols (66)

callbacks.h, libssh.so.4.2.0

```
ssh_set_channel_callbacks ( ssh_channel channel, ssh_channel_callbacks cb )  
ssh_threads_get_noop ( )  
ssh_threads_set_callbacks ( ssh_threads_callbacks_struct* cb )
```

callbacks.h, libssh_threads.so.4.2.0

```
ssh_threads_get_pthread ( )
```

libssh.h, libssh.so.4.2.0

```
ssh_channel_accept_x11 ( ssh_channel channel, int timeout_ms )  
ssh_channel_change_pty_size ( ssh_channel channel, int cols, int rows )  
ssh_channel_close ( ssh_channel channel )  
ssh_channel_free ( ssh_channel channel )  
ssh_channel_get_exit_status ( ssh_channel channel )  
ssh_channel_get_session ( ssh_channel channel )  
ssh_channel_is_closed ( ssh_channel channel )  
ssh_channel_is_eof ( ssh_channel channel )  
ssh_channel_is_open ( ssh_channel channel )  
ssh_channel_new ( ssh_session session )  
ssh_channel_open_forward ( ssh_channel channel, char const* remotehost, int remoteport, char const* sourcehost, int localport )  
ssh_channel_open_session ( ssh_channel channel )  
ssh_channel_poll ( ssh_channel channel, int is_stderr )  
ssh_channel_read ( ssh_channel channel, void* dest, uint32_t count, int is_stderr )  
ssh_channel_read_nonblocking ( ssh_channel channel, void* dest, uint32_t count, int is_stderr )  
ssh_channel_request_env ( ssh_channel channel, char const* name, char const* value )  
ssh_channel_request_exec ( ssh_channel channel, char const* cmd )  
ssh_channel_request_pty ( ssh_channel channel )  
ssh_channel_request_pty_size ( ssh_channel channel, char const* term, int cols, int rows )  
ssh_channel_request_send_signal ( ssh_channel channel, char const* signum )  
ssh_channel_request_sftp ( ssh_channel channel )  
ssh_channel_request_shell ( ssh_channel channel )
```

Отслеживание изменений

Инструменты: Upstream Tracker

<http://upstream-tracker.org/>

- Мониторинг и анализ библиотек в апстриме:
 - отслеживание новых версий
 - изменения в API/ABI
- Стабилизация апстрима



Отчеты: Upstream Tracker

API changes/compatibility report for the **libssh** library

libssh is a multplatform C library implementing the SSHv2 and SSHv1 protocol on client and server side. With libssh, you can remotely execute programs, transfer files, use a secure and transparent tunnel for your remote applications.

Links: [site](#) [doc](#) [src](#)

SONAMES: [libssh](#) libssh_threads

Version	Date	SONAME VERSION	Change Log	Backward Compatibility	Added Symbols	Removed Symbols	Headers Diff	API Changes / Binary Compatibility			PkgDiff Report
								High	Medium	Low	
Git	2012-09-30 02:10 MSK	4	changelog	98%	48 new	0	diff	0	11 changes	11 warnings	n/a
ABI v4.0											
0.5.2	2011-09-16	4	changelog	100%	0	0	diff	0	0	0	n/a
0.5.1	2011-08-09	4	changelog	100%	0	0	diff	0	0	0	n/a
0.5.0	2011-05-31	4	changelog	100%	1 new	0	diff	0	0	0	n/a
0.4.91	2011-03-23	4	changelog	100%	4 new	0	diff	0	0	0	n/a
0.4.90	2011-02-10	4	changelog	98.3%	66 new	3 removed	diff	1 change	1 change	3 warnings	report
0.4.8	2011-01-15	4	changelog	100%	0	0	diff	0	0	0	n/a
0.4.7	2010-12-27	4	changelog	100%	0	0	diff	0	0	0	n/a
0.4.6	2010-09-05	4	changelog	100%	0	0	diff	0	0	0	n/a
0.4.5	2010-07-13	4	changelog	100%	0	0	diff	0	0	0	n/a
0.4.4	2010-05-31	4	changelog	100%	0	0	diff	0	0	0	n/a
0.4.3	2010-05-18	4	changelog	92.5%	1 new	17 removed	diff	0	0	0	n/a
0.4.2	2010-03-15	4	changelog	99.8%	2 new	0	diff	0	11 changes	0	n/a
0.4.1	2010-02-13	4	changelog	100%	0	0	diff	0	0	0	n/a
0.4.0	2009-12-10	4	changelog	100%	0	0	diff	0	0	0	n/a
0.3.92	2009-11-20	4	changelog	99.8%	0	0	diff	0	4 changes	9 warnings	n/a
0.3.91	2009-10-29	4	changelog	86.2%	55 new	26 removed	diff	1 change	4 changes	225 warnings	n/a

Отчеты: Upstream Tracker

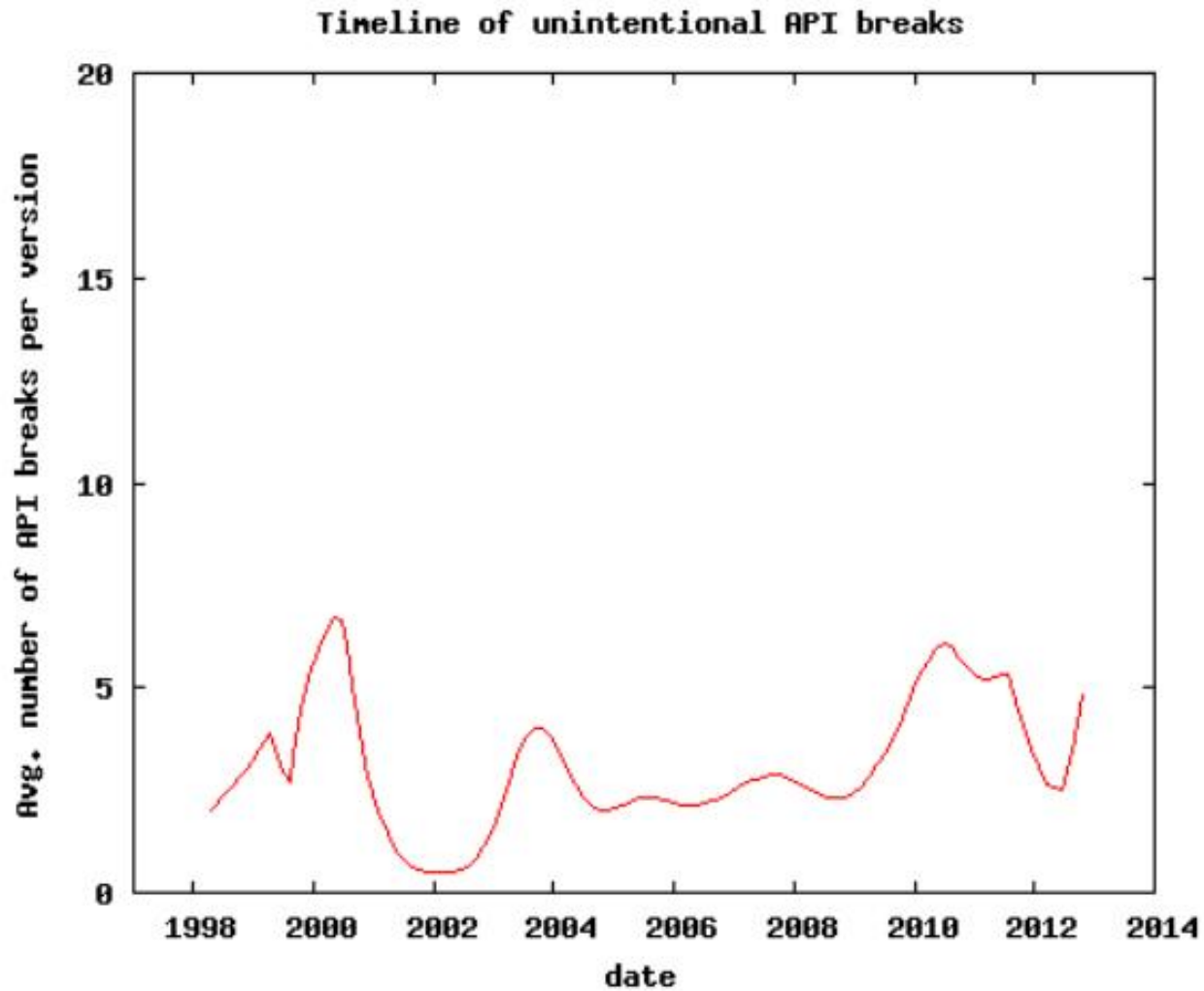

Инструменты: Updates Tracker

<http://upstream-tracker.org/updates/rosa/2012/>

➤ Определение устаревших пакетов

- по сравнению
 - с апстримом
 - другими дистрибутивами

Mageia, Mandriva, ...



Отчеты: Updates Tracker

ROSA 2012 Updates Tracker

This report for ROSA 2012 [main](#), [contrib](#), [non-free](#) and [restricted](#) repositories has been generated on 2012-09-30.

Leader
Up-to-date
 Section: Package: i.e. "aspell", "php", etc.
Outdated
Obsolete
 Status: Group: i.e. "video", "devel", etc.

[a](#)
[b](#)
[c](#)
[d](#)
[e](#)
[f](#)
[g](#)
[h](#)
[i](#)
[j](#)
[k](#)
[l](#)
[m](#)
[n](#)
[o](#)
[p](#)
[q](#)
[r](#)
[s](#)
[t](#)
[u](#)
[v](#)
[w](#)
[x](#)
[y](#)
[z](#)
[0-9](#)
[all](#)

Source Package ²⁸⁹	Available in Upstream (export this list)	Current in ROSA 2012	Current in ROSA 2011	Current in ROSA 2010	Current in ROSA 2009
a-a-p	1.091	1.091	1.091		
a2ps	4.14	4.14	4.14		4.14
a52dec	0.7.4	0.7.4	0.7.4		0.7.4
aalib	1.4rc5	1.4.0	1.4.0		1.4.0
abattis-cantarell-fonts	0.0.9	0.0.8	0.0.9		0.0.10.1
abe		1.1	1.1		1.1
abrt	2.0.12	2.0.10	2.0.10		2.0.7
ac3jack	2.0.3				
acfax		981011			
ack	2.00a01		1.9		
acl	2.2.51	2.2.51	2.2.51		2.2.51
acon	1.0.5	1.0.5	1.0.5		1.0.5
acpi	1.6	1.6	1.6		1.6
acpid	2.0.16	2.0.17	2.0.10	2.0.16	2.0.16
acr38u		1.7.10	1.7.10	1.7.10	1.7.10
adaptx		0.9.13	0.9.13	0.9.13	0.9.13
adjtimex	1.29	1.29	1.29	1.29	1.29
adns	1.4	1.4	1.4	1.4	
afbackup			3.5.3	3.5.3	3.5.3
affinity-search			0.1	0.1	
afio	2.5	2.5.1	2.5	2.5.1	2.5
afpfs-ng	0.8.1		0.8.1	0.8.1	0.8.1

Отстал от конкурентов

Отстал от апстрима

Инструменты: PkgDiff

<http://pkgdiff.github.com/pkgdiff/>

➤ Изменения в пакетах:

— визуализация

— классификация

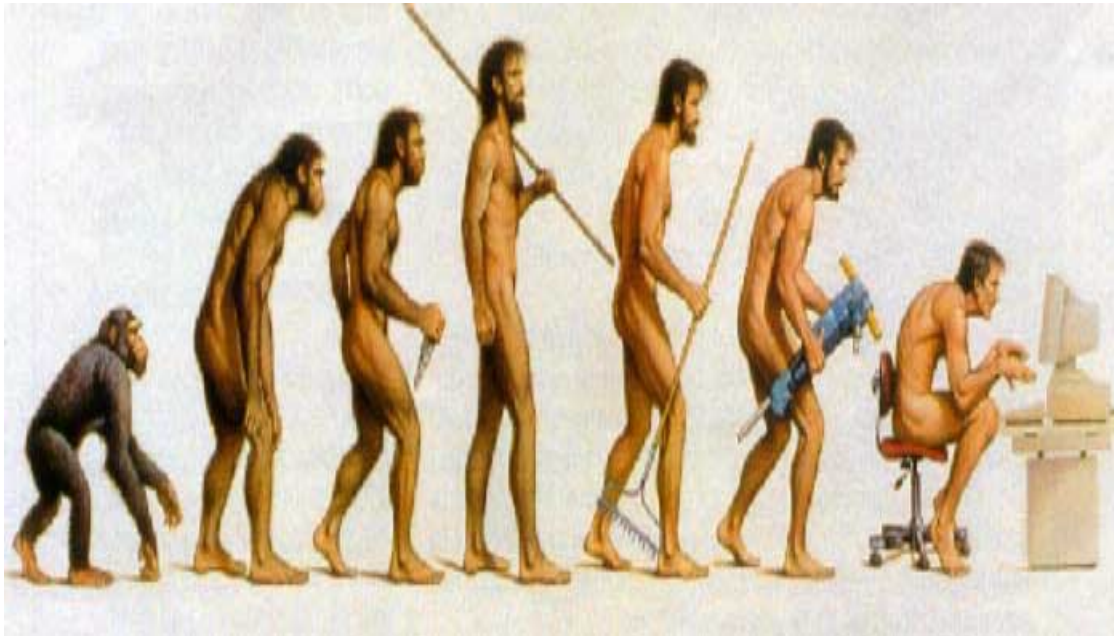

Отчеты: PkgDiff

Changes report for the **alsa-lib** package between **1.0.15** and **1.0.16** versions

added	unchanged
changed	removed

Test Info

Package Name	alsa-lib
Package Format	TAR.BZ2
Version #1	1.0.15
Version #2	1.0.16

Test Results

Total Packages	2
Total Files	383
Verdict	Changed (4.2%)



Changes In Files

File Type	Total	Added	Removed	Changed
Header file	75	0	6	28
C program	119	2	3	47
Spec file	1	0	0	0
Shell program	11	0	0	2
Automake file	55	0	2	32
Configuration file	69	0	0	4
Lisp program	4	0	0	0
M4 macro file	3	0	0	0



Отчеты: PkgDiff

Header Files (75)

Name	Status	Delta	Visual Diff	Detailed Report
include/alisp.h	unchanged			
include/alsa-symbols.h	unchanged			
include/aserver.h	unchanged			
include/asoundef.h	unchanged			
include/asoundlib-head.h	unchanged			
include/asoundlib-tail.h	unchanged			
include/asoundlib.h	changed	2.7%		
include/conf.h	unchanged			
include/config.h.in	changed	4.8%	diff	
include/control.h	changed	4.9%	diff	
include/control_external.h	unchanged			
include/conv.h	removed			
include/error.h	unchanged			
include/global.h	changed	3.3%	diff	
include/hwdep.h	changed	7.8%	diff	
include/iatomic.h	unchanged			
include/input.h	unchanged			
include/instr.h	removed			
include/list.h	unchanged			
include/local.h	changed	4.9%	diff	
include/mixer.h	changed	2.5%	diff	



Оценка изменений

Присоединяйтесь к сообществу РОСА

- <http://upstream-tracker.org/>
- <https://abf.rosalinux.ru/>
- <http://fba.rosalinux.ru/>
- <http://rosalab.ru/>



E-mail:

rubanov@rosalab.ru

aponomarenko@rosalab.ru